



CorePro LED PLC 4P



CorePro LED PLC 9W 830 4P G24q-3

The CorePro LED PLC 4P integrates a LED light source into a traditional fluorescent form factor. This product is the ideal solution for uplamping in general lighting applications: it meets basic lighting requirements, offers significant energy savings and is environmentally friendly.

Product data

General Information	
Cap base	G24q-3
Nominal lifetime	30,000 h
Switching Cycle	50,000
Lighting Technology	LED
Flux measurement reference	Sphere
CE mark	Yes
EU RoHS compliant	Yes

Light Technical	
Colour Code	830 [CCT of 3000K]
Beam angle (nom.)	120 degree(s)
Luminous Flux	950 lm
Colour designation	White (WH)
Correlated Colour Temperature	3000 K
Luminous efficacy (rated) (nom.)	100.00 lm/W
Colour consistency	<6
Colour rendering index (CRI)	83
LLMF at end of nominal lifetime (nom.)	70 %
Photobiological safety according to EN 62471	RG0

Operating and Electrical	
Line Frequency	30000-80000 Hz

Input frequency	30000-80000 Hz
Power Consumption	9 W
Lamp current (max.)	400 mA
Lamp current (min.)	250 mA
Starting time (nom.)	0.5 s
Warm-up time to 60% light	0.5 s
Power Factor (Fraction)	0.9
Voltage (nom.)	20-50 V
LED alternative to fluorescent lamp power	26 W
Inrush current at mains	-
Max. lamp no. on MCB B type 10A — Mains	-
Max. lamp no. on MCB B type 10A — EM ballast without Comp. Cap.	-
Max. lamp no. on MCB B type 10A — EM ballast with Comp. Cap.	-
Max. lamp no. on MCB B type 16A — Mains	-
Max. lamp no. on MCB B type 16A — EM ballast without Comp. Cap.	-
Max. lamp no. on MCB B type 16A — EM ballast with Comp. Cap.	-
Ballast Compatibility	HF

CorePro LED PLC 4P

Temperature

Ambient temperature range	-20°C to 35°C
T-Case maximum (nom.)	76 °C

Controls and Dimming

Dimmable	No
----------	----

Mechanical and Housing

Bulb material	Plastic
Product length	200 mm
Bulb shape	PL-C

Approval and Application

Energy Efficiency Class	F
Energy-saving product	Yes
Approval marks	TUV CE marking RoHS compliance KEMA Keur certificate

Energy consumption kWh/1,000 hours	9 kWh
EPREL registration number	403550

Product Data

Order product name	CorePro LED PLC 9W 830 4P G24q-3
Full product name	CorePro LED PLC 9W 830 4P G24q-3
Full EOC	871869654115900
Order code	54115900
Material no. (12 NC)	929001200802
SAP numerator – quantity per pack	1
EAN/UPC – Product/Case	8718696541159
Numerator – packs per outer box	10
EAN/UPC - Case	8718696541166

Dimensional drawing

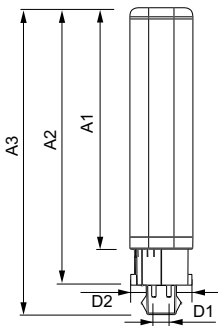

Product	D1	D2	A1	A2	A3
CorePro LED PLC 9W 830 4P G24q-3	24.3 mm	28.4 mm	128.8 mm	148 mm	163.6 mm

Photometric data

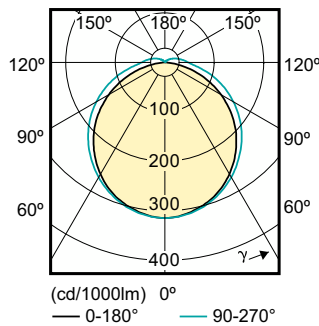
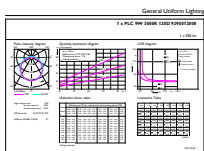

General uniform lighting - CorePro LED PLC 9W 830 4P G24q-3

Light Distribution Diagram - CorePro LED PLC 9W 830 4P G24q-3

CorePro LED PLC 4P

Photometric data

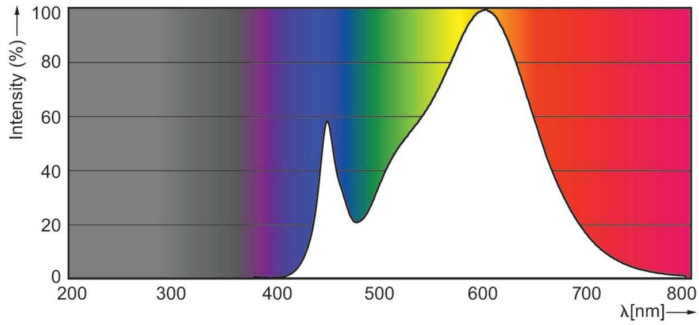

Spectral Power Distribution Colour - CorePro LED PLC 9W 830 4P G24q-3

Lifetime

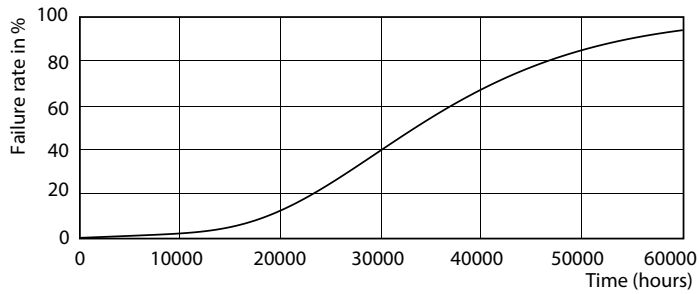

Life Expectancy Diagram - CorePro LED PLC 9W 830 4P G24q-3

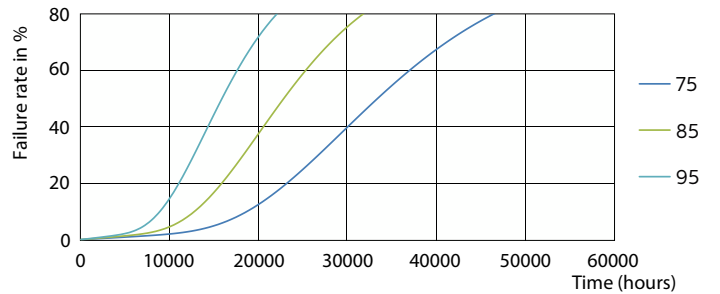

Life Expectancy Diagram - CorePro LED PLC 9W 830 4P G24q-3

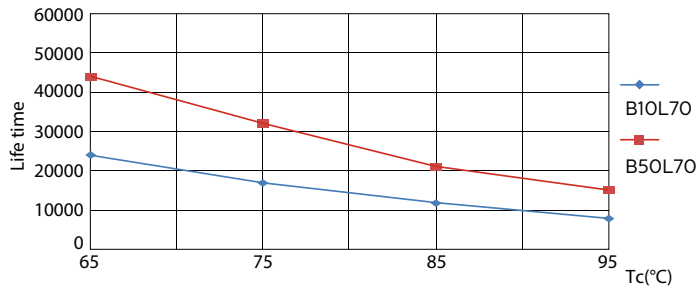

Life Expectancy Diagram - CorePro LED PLC 9W 830 4P G24q-3

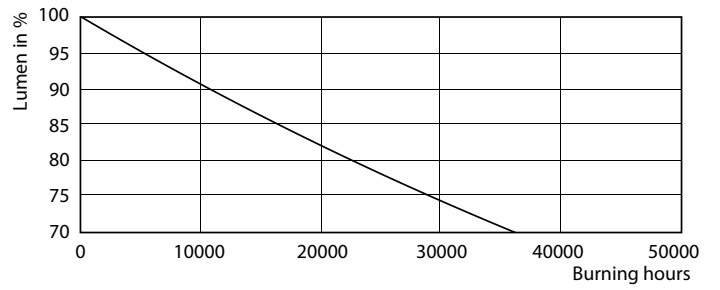

Lumen Maintenance Diagram - CorePro LED PLC 9W 830 4P G24q-3

CorePro LED PLC 4P

Lifetime

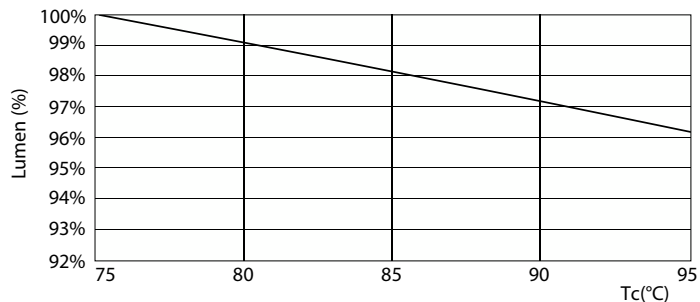

Lumen Maintenance Diagram - CorePro LED PLC 9W 830 4P G24q-3

