

# PRODUCT DATASHEET

## DL ALU DN 200 25 W 4000 K IP44/IP20 WT

DOWNLIGHT ALU | Downlight luminaires with aluminum housing



### Areas of application

- Direct replacement for luminaires with compact fluorescent lamps
- General illumination
- Public areas
- Stairways
- Corridors
- Foyers
- Shops

### Product benefits

- High luminous efficacy
- Energy savings up to 60 % (compared to luminaires that use CFL lamps)
- Very homogenous light
- Functional design
- Easy installation with fast connection
- External driver for extended flexibility (compatible with selected DALI drivers)
- 5 years guarantee

### Product features

- Diameter of required ceiling cut-out: 150 mm or 200 mm (depending on version)
- Type of protection: IP44



## TECHNICAL DATA

### Electrical data

|   |                     |
|---|---------------------|
| Nominal wattage   | 25.00 W             |
| Nominal voltage   | 220...240 V         |
| Mains frequency   | 50...60 Hz          |
| Nominal current   | 110 mA              |
| Inrush current  | 7 A                 |
| Max. number of luminaires per miniature circuit breaker B16 | 107                 |
| Max. number of luminaires per miniature circuit breaker C10 | 72                  |
| Max. number of luminaires per miniature circuit breaker C16 | 116                 |
| Power factor $\lambda$                                      | > 0.90              |
| Total harmonic distortion                                   | < 20 %              |
| Protection class  | II                  |
| Operating mode  | External LED driver |

### Photometrical data

|  |                     |
|--|---------------------|
| Luminous flux                                | 2370 lm             |
| Luminous efficacy                            | 95 lm/W             |
| Color temperature                            | 4000 K              |
| Light color (designation)                    | Cool White          |
| Color rendering index Ra                     | > 80                |
| Standard deviation of color matching         | ≤6 sdc <sub>m</sub> |
| Luminous intensity                           | -                   |
| Flickering metric (Pst LM)                   | -                   |
| Stroboscope effect metric (SVM)              | -                   |
| Photobiological safety group acc. to EN62778 | RG0                 |
| Photobiological safety group acc. to EN62471 | RG0                 |
| Beam angle                                   | 100 °               |

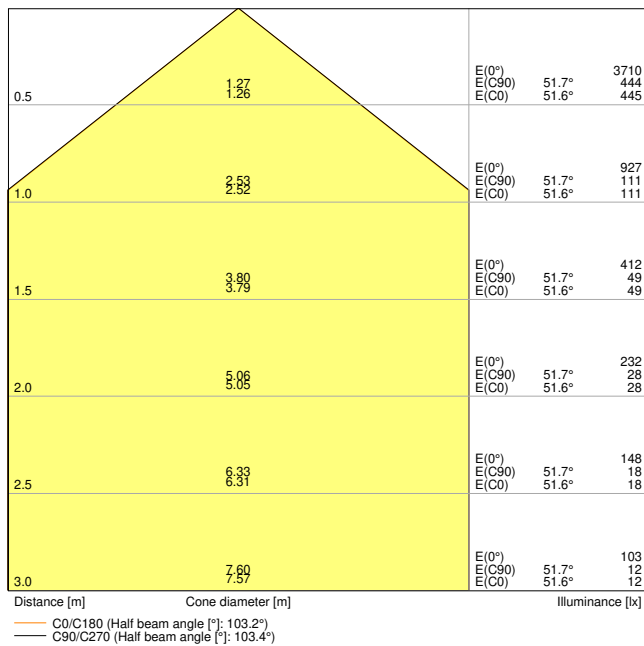

DL ALU DN200 25W 4000K WT IP44

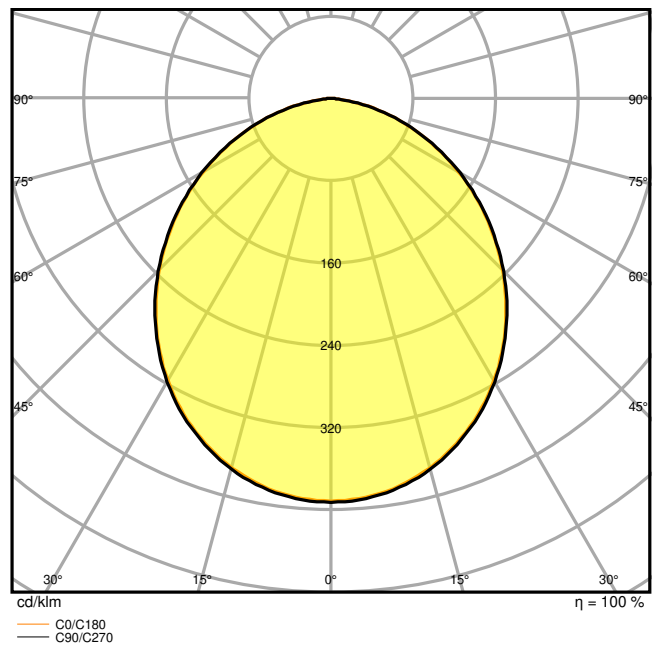

DL ALU 25W4000K WT IP44

Dimensions & Weight

|                |           |
|----------------|-----------|
| Diameter       | 215.00 mm |
| Height         | 61.00 mm  |
| Product weight | 600.00 g  |

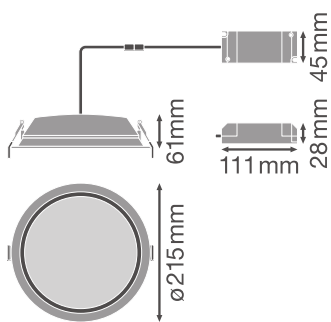

DL ALU DN200

Materials & Colors

|               |       |
|---------------|-------|
| Product color | White |
| Housing color | White |

|  |                               |
|--|-------------------------------|
| Body material                              | Aluminum                      |
| Cover material                             | Polymethylmethacrylate (PMMA) |
| Glow Wire Test according to IEC 60695-2-12 | 650 °C                        |

### Application & Mounting

|  |                              |
|--|------------------------------|
| Ambient temperature range              | -20...+45 °C                 |
| Temperature range at storage           | -20...+80 °C                 |
| Type of connection                     | Screw terminal, 2-Pole (L,N) |
| Type of protection                     | IP44/IP20                    |
| Protection class IK (shock resistance) | IK02                         |
| Dimmable                               | No                           |
| Mounting type                          | Recessed                     |
| Mounting location                      | Ceiling                      |
| Application environment                | Indoor                       |
| Mounting diameter                      | 200 mm                       |
| Mounting depth                         | 120 mm                       |
| LED module replaceable                 | Not replaceable              |
| With light source                      | Yes                          |

### Lifespan

|                            |                       |
|----------------------------|-----------------------|
| Lifespan L70/B50 at 25 °C  | 50000 h <sup>1)</sup> |
| Lifespan L80/B10 at 25 °C  | 45000 h <sup>1)</sup> |
| Lifespan L90/B10 at 25 °C  | 30000 h               |
| Number of switching cycles | 100000                |

<sup>1)</sup> t[h]: L70 / B50 @ 25 °C (Ta), t[h]: L80 / B10 @ 25 °C (Ta), t[h]: L90 / B10 @ 25 °C (Ta)

### Control gear

|                             |        |
|-----------------------------|--------|
| Output current              | 550 mA |
| ECG - Output ripple current | < 30 % |
| ECG - Length                | 111 mm |
| ECG - Width                 | 45 mm  |
| ECG - Height                | 28 mm  |

### Certificates & Standards

|  |                          |
|--|--------------------------|
| Standards  | CE / CB / ENEC / TÜV SÜD |
| Luminaire with limited surface temperature, "D sign" | No                       |

Ball shot safe

No

## Additional product data







Number of illuminants





Not relevant



## Accessories Optional

| Product image   | Product name      | EAN           |
|---|-------------------|---------------|
|  | EM CONVERSION BOX | 4058075237025 |



## DOWNLOAD DATA

| Documents and certificates   | Document name                                   |
|--|---|
|  User instruction                  | UI Downlight ALU                                |
|  Addon Technical Information      | LSI DL ALU                                      |
|  On-Pack-Info                    | Legal Insert Downlight LED ALU+Comfort          |
|  Declarations Of Conformity CE   | CE-Certificate Downlight ALU TUV                |
|  Declarations Of Conformity CE   | EU Declaration of Conformity DOWNLIGHT ALU LEDV |
|  Declarations Of Conformity UKCA | UKCA Declaration of Conformity DL ALU WT IP44   |

| Photometric and lighting design files   | Document name                  |
|---|--------------------------------|
|  IES file (IES)       | DL ALU DN200 25W 4000K WT IP44 |
|  LDT file (Eulumdat)  | DL ALU DN200 25W 4000K WT IP44 |
|  ULD file (DIALux)    | DOWNLIGHTALU20025W4000KIP44WT  |
|  ROLF file (RELUX)    | DL ALU DN200 25W-4000K         |
|  UGR file (UGR table) | DL ALU 25W4000K WT IP44        |

| Photometric and lighting design files  |               | Document name                  |
|--|---------------|--------------------------------|
|  | LDC typ cone  | DL ALU DN200 25W 4000K WT IP44 |
|  | LDC typ polar | DL ALU 25W4000K WT IP44        |

| CAD/BIM files  |              | Document name  |
|--|--------------|----------------|
|  | BIM_Revit_3D | Downlight ALU  |
|  | CAD_STEP_3D  | DL ALU 25W 35W |

| Tender texts   |                  | Document name                                |
|--|------------------|--|
|  | Tender documents | DOWNLIGHT ALU 200 25 W 4000 K IP44IP20 WT-EN |

**LOGISTICAL DATA**

| Product code  | Packaging unit (Pieces/Unit) | Dimensions (length x width x height) | Gross weight | Volume                |
|---------------|------------------------------|--------------------------------------|--------------|-----------------------|
| 4058075091511 | Folding box<br>1             | 225 mm x 225 mm x 110 mm             | 775.00 g     | 5.57 dm <sup>3</sup>  |
| 4058075091528 | Shipping box<br>8            | 462 mm x 462 mm x 240 mm             | 7020.00 g    | 51.23 dm <sup>3</sup> |

The mentioned product code describes the smallest quantity unit which can be ordered. One shipping unit can contain one or more single products. When placing an order, for the quantity please enter single or multiples of a shipping unit.

**ADDITIONAL CATALOG INFORMATION**

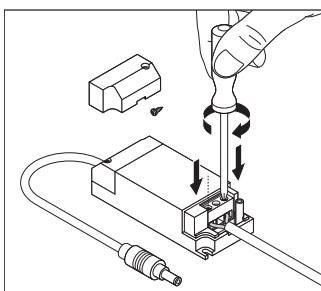

**References / Links**

– For Guarantee see [www.ledvance.com/guarantee](http://www.ledvance.com/guarantee)

**DISCLAIMER**

Subject to change without notice. Errors and omission excepted. Always make sure to use the most recent release.